



USER GUIDE

TV Streamer 2





Welcome

Congratulations on your purchase of a TV Streamer 2.

TV Streamer 2 will provide you with high quality streamed audio from your TV, sound system, personal computer or similar device directly to your hearing instruments.

Please read this manual carefully to fully benefit from the TV Streamer 2. Ask your hearing care professional if you have any questions.

For your safety, carefully read the chapter Important Information, on pages 28-29

Model: SAS-3

FCC ID: X26SAS-3





Statement:



This device complies with Part 15 of the FCC Rules.

Operation is subject to the following two conditions: (1) this device may not cause harmful interference, and (2) this device must accept any interference received, including interference that may cause undesired operation.

Note: This equipment has been tested and found to comply with the limits for a Class B digital device, pursuant to part 15 of the FCC Rules. These limits are designed to provide reasonable protection against harmful interference in a residential installation. This equipment generates, uses and can radiate radio frequency energy and, if not installed and used in accordance with the instructions, may cause harmful interference to radio communications.

However, there is no guarantee that interference will not occur in a particular installation. If this equipment does cause harmful interference to radio or television reception, which can be determined by turning the equipment off and on, the user is encouraged to try to correct the interference by one or more of the following measures:





Reorient or relocate the receiving antenna.

Increase the separation between the equipment and receiver.

Connect the equipment into an outlet on a circuit different from the receiver is connected.

Consult the dealer or an experienced radio/TV technician for help.

Changes or modifications can void the user's authority to operate the equipment.

Intended use



TV Streamer 2 is intended to enable wireless hearing instrument users to better follow TV or other audio programmes. The essential performance of the TV Streamer 2 is to transfer signals from a TV set or other audio device to wireless hearing instruments.



List of countries

Products are intended for sale in countries within European Economic Area as well as Switzerland.



National restrictions:

Norway: You are not allowed to operate the equipment within 20 km of the centre of Ny Ålesund.

This product is in compliance with the following regulatory standards:

In EU : The device conforms to the Essential Requirements according to - Annex I of Council Directive 93/42/EE C for medical devices (MDD) and essential requirements and other relevant provisions of Directive 1999/5/EC (R&TTE). The declaration of conformity may be consulted at www.resound.com

In US: FCC CFR 47 Part 15, subpart C.

Other identified applicable international regulatory requirements in countries outside EU and US. Please refer to local country requirements for these areas.

The product is categorized as receiver category 2 according to EN 300 328.

Model: SAS-3

IC: 6941C-SAS3

This Class B digital apparatus complies with Canadian ICES-003.

Cet appareil numérique de la classe B est conforme à la norme NMB-003 du Canada.



Operation is subject to the following two conditions: (1) this device may not cause interference, and (2) this device must accept any interference, including interference that may cause undesired operation of the device.

L'exploitation est autorisée aux deux conditions suivantes: (1) l'appareil ne doit pas produire de brouillage, et (2) l'utilisateur de l'appareil doit accepter tout brouillage radioélectrique subi, même si le brouillage est susceptible d'en compromettre le fonctionnement.

In JP:

This device has been granted a designation number by Ministry of Internal Affairs and Communications under “Ordinance concerning Technical Regulations Conformity Certification etc. of Specified Radio Equipment (特定無線設備の技術基準適合証明 等に関する規則)” Article 2-1-19 “This device should not be modified (otherwise the granted designation number will be invalid)”.





Contents

Description	8
Getting Started	10
Pairing to your hearing instruments.	18
Start and stop streaming	21
Controls	24
Adjustable delay mode	26
Important Information	28
Technical specifications	30
Warranty	30
Troubleshooting guide	32



Description

- 1 Micro-USB power socket
- 2 Pairing button
- 3 Mono/stereo switch
- 4 Analog mini-jack audio input
- 5 Optical (Toslink) audio input
- 6 Coaxial audio input

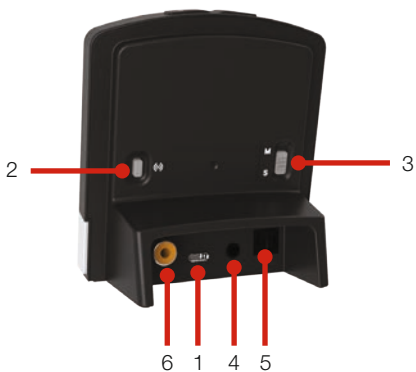

8

- 7 Increase volume
- 8 Decrease volume
- 9 Power light (green)
- 10 Activity light (yellow)
- 11 Wall plug
- 12 Mini-USB plug

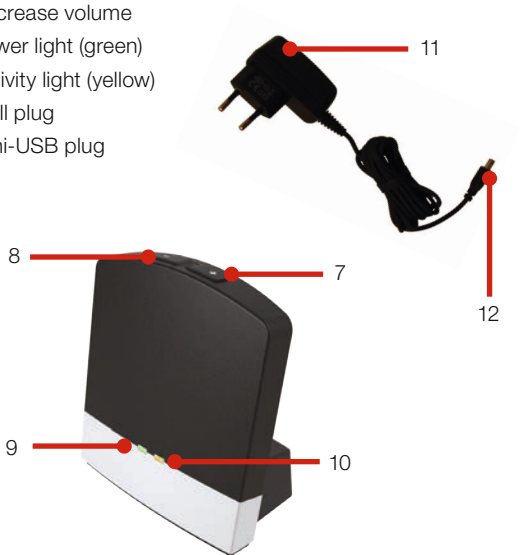

Getting Started

Installing the TV Streamer 2

Depending on your TV, sound system, computer or other audio setup, the installation of TV Streamer 2 may be done in several ways described in the following section. The following steps will guide you through the pairing and connecting process, which can be easily accomplished by almost anyone. Start by connecting cables between the TV Streamer 2 and the audio source and finish by pairing the TV Streamer 2 to your hearing instruments.



The TV Streamer 2 supports both analog and digital audio input. Please read the following sections for information about supported audio formats and how to connect the TV Streamer 2 to audio sources.

Connecting the TV Streamer 2 to an analog audio source (E.g. TV or sound system)

1. Connect the power supply to the wall socket and insert the cable into the micro-USB socket on the TV Streamer 2
2. Insert the male stereo mini-jack on the audio cable into the female stereo mini-jack input on the TV Streamer 2 (4 on page 8)
3. Plug the other end audio cord into the "AUDIO OUT" terminals on the audio source

4. The "AUDIO OUT" is usually marked "L – R" for left and right, and can usually be found on the back of the audio source

 *Note:* With this installation, most audio sources will send sound to both hearing instruments and additional speakers connected to the audio source simultaneously. On some audio sources you can adjust the balance between the AUDIO OUT and the speakers – consult your audio source manual for instructions.

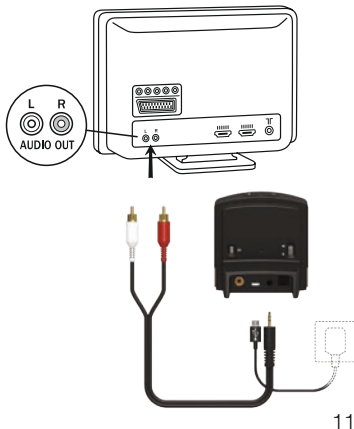

Alternative analog audio cable installations:

If it is not possible to connect the TV Streamer 2 to the AUDIO OUTPUT of the audio source using the red and white plugs, the following installation alternatives can be used:

Mini-jack adaptor:

1. Connect the power supply to the wall socket and insert the cable into the micro-USB socket on TV Streamer 2
2. Insert the male stereo mini-jack on the audio cable into the female stereo mini-jack input on the TV Streamer 2 (4 on page 8)
3. Connect the stereo mini-jack adaptor to the red and white plugs at the other end of the audio cable
4. Plug the stereo mini-jack adaptor into the audio sources' "HEADPHONE" output terminal, or alternatively into your computers' audio terminal



Note: The HEADPHONE output terminal is usually located on the side or front of the audio source. When using the HEADPHONE terminal, usually only the person wearing the hearing instruments will hear the sound, and audio source speakers are muted.

If muted speakers are not desired, please refer to the first installation, or the one on the following page. Your audio source may support speakers and HEADPHONE being on simultaneously; check your audio source manual for instructions.

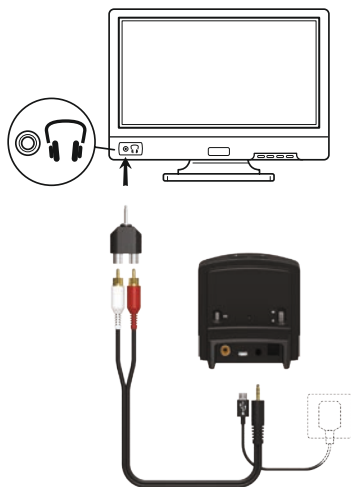



Scart adapter:

1. Connect the power supply to the wall socket and insert the cable into the micro-USB socket on TV Streamer 2
2. Insert the male stereo mini-jack on the audio cable into the female stereo mini-jack input on the TV Streamer 2 (4 on page 8)
3. Connect the scart adapter to the red and white plugs at the other end of the audio cable
4. Plug the scart adapter into the audio source's scart terminal

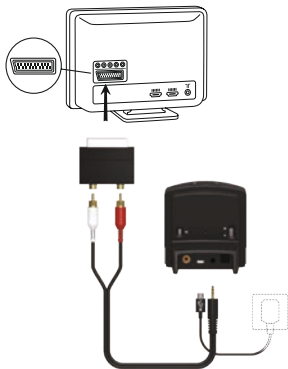
 *Note: The scart output terminal is usually located on the back or side of the audio source. Please consult the manual of your audio source if additional configuration of the scart output is needed.*





Connecting the TV Streamer 2 to a digital audio source (E.g. TV or sound system)



The TV Streamer 2 supports both analog and digital audio input. When using digital audio input the following formats are supported:

Stereo PCM

- Sample rate: Up to 192 kHz
- Sample resolution: Up to 32 bit



Dolby Digital

- Channels: Max 5.1
 - Bitrate: 32 kbs to 640 kbs
 - Sample rate: 32, 44.1 and 48 kHz
- 

Note: Dolby Digital Plus (requiring an HDMI interface), Dolby TrueHD, Dolby Pro Logic, Dolby Digital EX, Dolby Digital Surround EX, and AAC (Advanced Audio Codec) are not supported.

Using the optical (Toslink) audio input

1. Connect the power supply to the wall socket and insert the cable into the micro-USB socket on TV Streamer 2
2. Insert one of the plugs on the optical audio cable into the optical audio input socket (5 on page 8) on TV Streamer 2

Note: Most optical cables are delivered with a small protective cap to protect the tip of the cable. Please remove this protective cap before inserting the cable

3. Plug the other end of the optical audio cable into the "Digital Audio Out/Optical" on your audio source

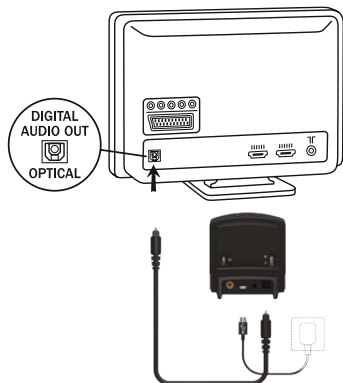

Using the coaxial audio input

1. Connect the power supply to the wall socket and insert the cable into the micro-USB socket on TV Streamer 2
2. Connect one of the plugs on the coaxial audio cable to the coaxial plug (6 on page 8) on TV Streamer 2
3. Plug the other end of the coaxial audio cable into the “Digital Audio Out/Coaxial” on your audio source

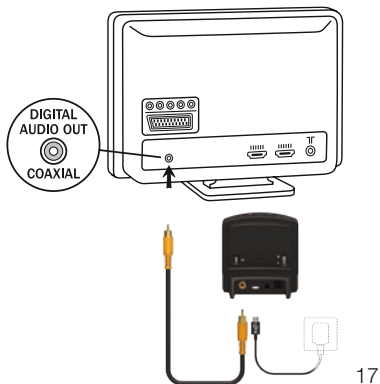



Pairing to your hearing instruments



Note! The following information is intended primarily for your hearing care professional, who in most cases will complete the necessary tasks before the TV Streamer 2 can be used with your hearing instruments. However, the process is designed to be simple and most people can do it themselves.



It is possible to pair up to three streaming devices - e.g. two TV Streamers and one Clip-On Microphone (optional accessory) - with a given pair of hearing instruments. Therefore channel 1, 2 or 3 must be selected when starting the pairing process.



Pairing the TV Streamer 2 in channel 1



1. Make sure that the TV Streamer 2 power supply is plugged into a wall socket and that the green light indicator on the front of the TV Streamer 2 (9 on page 9) is ON. Your hearing instruments must be OFF - open the battery door
2. Press the pairing button on the TV Streamer 2 (2 on page 8) once. The yellow light indicator on the front of the TV Streamer 2 (10 on page 9) will now blink once every 2 seconds to indicate that the TV Streamer 2 is ready to be paired in channel 1. Your TV Streamer 2 will remain in pairing mode for 20 seconds

- 
- 
3. While pairing mode is activated, close the battery doors of both hearing instruments and make sure they are ON. A successful pairing will be indicated by an audible melody being played in both hearing instruments. You are now ready to use the TV Streamer 2

Pairing the TV Streamer 2 in channel 2

1. Press the pairing button twice. The yellow light indicator on the front of the TV Streamer 2 will now blink twice every 2 seconds to indicate that it is ready to be paired in channel 2
2. While in pairing mode close the battery doors on the hearing instruments

Pairing the TV Streamer 2 in channel 3

1. Press the pairing button three times. The yellow light indicator on the front of the TV Streamer 2 will now blink three times every 2 seconds to indicate that it is ready to be paired in channel 3
2. While in pairing mode close the battery doors on the hearing instruments



Pairing blinking pattern:



Pairing button pushes	Light indicator pattern				Channel
1	1	1	1	1	1
2	1 2	1 2	1 2	1 2	2
3	1 2 3	1 2 3	1 2 3	1 2 3	3





Start and stop streaming

Turn on the TV, sound system, computer or other audio device connected to TV Streamer 2. Make sure your hearing instruments are turned on as well. Streaming may be started in one of two ways.

1. Press and hold the push button on either hearing instrument for about three seconds. This must be done separately on both hearing instruments, in order to hear streamed audio in both ears, unless your hearing instruments have been set up with device-to-device synchronisation. Once TV Streamer 2 has been connected, an audible melody will play in your hearing instruments and will be followed by the streamed sound
 2. If you have a Remote Control (optional), simply press the streaming button on this Remote Control. Once the hearing instruments connect to TV Streamer 2, an audible melody will play in both ears to confirm the presence of streamed audio and a streaming icon will appear in the display. The streamed sound can now be heard in your hearing instruments
- 
- 

Start streaming on a 2nd or 3rd TV Streamer 2 unit

If more than one TV Streamer 2 device is available, you may press the streaming button on the Remote Control a 2nd or 3rd time, depending on which TV Streamer 2 device you want to listen to.

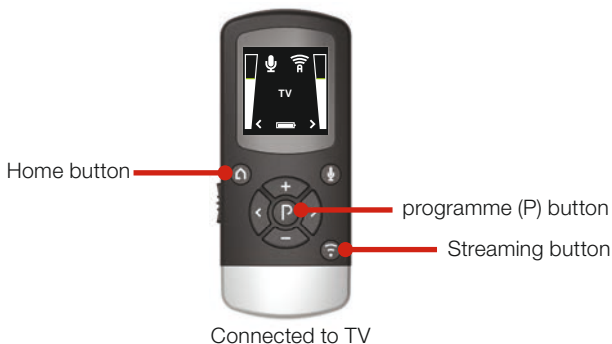

Up to 3 TV Streamer 2 units are initially labeled by letter designator A, B or C, and the streaming device in use is shown on the Remote Control display.

If you do not have a Remote Control, press and hold the push button for about 3 seconds on the hearing instrument a 2nd or 3rd time to access the 2nd or 3rd streaming unit.



Stop streaming

Shortly press the push button on either hearing instrument. This will cancel streaming on the side pressed and return to the last programme used.

Note: If your hearing instruments have device-to-device programme synchronisation, enabled a press on one side will take both hearing instruments back to the last programme used.

With the Remote Control (optional) you just have to press the “P” button, located in the center of the key pad. This will return the hearing instruments to the last programme used. You may also press the home button to return to your default settings.



If you are using the telephone with Phone Clip+ or Auto Phone, streaming from the TV Streamer 2 will be temporarily disrupted. When you have ended your phone call, streaming will resume.



 *Note! You may get out of range (>7m) from your TV Streamer 2. If you get back in range within 5 minutes, your hearing instruments will automatically reconnect and continue streaming.*



Controls

Adjust volume

The TV Streamer 2 is designed to provide a comfortable listening level from the moment it is activated. However, for some devices or listening environments it may be desirable to adjust the listening volume, and doing so can be accomplished in a variety of ways. Keep in mind that volume adjustments on the TV Streamer 2 apply to the streamed signal only, not the volume of normal environmental sounds.



Use the “+” and “-” keys (7 and 8 on page 9) to adjust volume to a comfortable level. Make sure that your hearing instruments are comfortably adjusted before you change the settings with the volume control. In most cases this adjustment should only be made one time, as TV Streamer 2 will store the latest set volume level.



Use the Remote Control 2 (optional) to adjust both the streaming volume level and the hearing instrument microphone volume level in the hearing instrument*. Ask your hearing care professional for more information about this accessory.

The volume can, in some cases, be further adjusted at the signal source, for example by turning the TV volume down. This will adjust the volume of the streamed sound transmitted wirelessly to

**Adjustment of both hearing instrument and streaming volume is only available with Remote Control 2.*





the hearing instruments. Adjusting the TV volume will affect the listening volume in the room as well.

Mono/stereo control

The two-position switch (3 on page 8) may be used to set Stereo (two channels) or Mono (one channel) audio streaming. For binaural fittings, the switch should preferably be set to the Stereo position. For monaural fitting it should be set to the Mono position.









Adjustable delay mode

In rare cases there may be a misalignment between the audio streamed to the hearing instruments and the sound coming from the TV speakers (echo) or even a misalignment between the streamed audio and the TV picture (lip-sync). This may be evident in more complex audio setups where the TV Streamer 2 is not connected directly to the TV (e.g. through a set-top box or other auxiliary unit).

To overcome such misalignments the streaming delay from the TV Streamer 2 can be adjusted as follows:

- 
- 
1. Make sure that the TV Streamer 2 is turned on and that your hearing instruments are receiving the streamed audio
 2. Press and hold the pairing button (2 on page 8) for 3 seconds. Now the TV Streamer 2 will enter into the adjustable delay mode, where the green light indicator on the front of the TV Streamer 2 will blink once every 2 seconds. The yellow light indicator will be on whenever an audio signal is present
 3. Use the “+” and “-“ key (7 and 8 on page 9) on the top of the TV Streamer 2 to increase or decrease the delay of the streamed signal in 10 ms steps. The streamed signal can be delayed in the range of 0-250 ms
 4. When the optimal alignment between the audio streamed to the hearing instruments and the sound coming from the TV





speakers or alignment between the streamed audio and the TV picture has been reached, press and hold the pairing button for 3 seconds. Now the TV Streamer 2 will resume normal operation, indicated by the green light indicator being constantly on

The offset set in adjustable delay mode will be stored in the TV Streamer 2.

If you do not exit the adjustable delay mode by pressing and holding the pairing button down for 3 seconds, the TV Streamer 2 will automatically resume normal operation after 30 minutes.

To reset the delay to 0 ms (factory setting), press and hold the pairing button while simultaneously powering on the TV Streamer 2.



Important Information

Maintenance and Care

Clean the TV Streamer 2 using a damp cloth. Never use household cleaning products (washing powder, soap, etc.) or alcohol to clean the device.

When the TV Streamer 2 is not being used for longer periods of time, unplug the power supply from the wall socket.





General warnings 

Keep the TV Streamer 2 out of reach of children under 3 years.

The TV Streamer 2 uses low-powered digitally coded transmissions in order to communicate with other wireless devices. Although unlikely, nearby electronic devices may be affected. In that case, move the TV Streamer 2 away from the affected electronic device.

Use the TV Streamer 2 only with the power supply unit that has been supplied together with the product. The use of any other types may damage or destroy the product and could be dangerous. Use of other power supplies may invalidate any approval or warranty.

- 
- When you disconnect the power cord, grasp and pull the plug, not the cord
 - Never use a power supply that is damaged
 - Do not attempt to disassemble the power supply as it may expose you to dangerous electric shock
 - Do not use the power supply outdoors or in damp areas
- 

When using the TV Streamer 2 and the device is affected by electromagnetic interference, move away from the source.

General precautions 

Your hearing instrument and the TV Streamer 2 were given a unique communication network code during the fitting. This ensures that TV Streamer 2 will not affect hearing instruments worn by others.

High-powered electronic equipment, larger electronic installations and metallic structures may significantly reduce the operating range.

Use only original accessories.

Do not make any changes or modifications to the TV Streamer 2.

Opening the TV Streamer 2 might damage it. If problems occur which cannot be resolved by following the remedy guidelines in the troubleshooting section of this user guide, consult your hearing care professional.

The TV Streamer 2 may only be repaired by an authorized service center.

Do not use the TV Streamer 2 in areas where RF transmission is prohibited, e.g. airplanes etc.

Only connect the TV Streamer 2 to connections for which it is explicitly intended.



Technical specifications

Operating range:	Up to 7 meters
Power supply:	External wall adapter
Wireless:	2.4 GHz
Operating temperature:	0 to 55 °C
Storage temperature:	-20 to 60 °C

Temperature test, transport and storage information



The product is subject to various tests in temperature and damp heating cycling between -25 °C and +70 °C according to internal and industry standards.





Warranty

The TV Streamer 2 is covered by a limited warranty issued by the manufacturer for a period of 12 months from the day of the original purchase. Please notice that extended warranties may apply in your country. Please contact your local hearing care professional for more information.

What is covered by this warranty?

Any electrical component, that because of workmanship, manu-



facturing or design defects fails to function properly under normal use during life of this warranty will be replaced or repaired at no charge for parts or labour when returned to the point of purchase.

If it is determined that repair is not feasible, the entire unit may be replaced with an equivalent unit upon mutual agreement of the hearing care professional and the customer.

What is not covered by this warranty?



Problems arising from improper handling or care, excessive use, accidents, repairs made by an unauthorized party, exposure to corrosive conditions or damage due to foreign objects entering the device are NOT covered by the limited warranty and may void it. The above warranty does not affect any legal rights that you might have under applicable national legislation governing sale of consumer products. Your hearing care professional may have issued a warranty that goes beyond the clauses of this limited warranty. Please consult your hearing care professional for further information.



Serial number: _____

Date of purchase: _____



TROUBLESHOOTING GUIDE

SYMPTOM	CAUSE
<i>The streaming button on the Remote Control is pressed but with no effect at all</i>	<p>The TV Streamer 2 and hearing instruments have not been paired</p> <p>The Remote Control and hearing instruments are not within wireless range</p>
<i>The push button on the hearing instrument has been pressed for more than 3 seconds but with no effect at all</i>	<p>The TV Streamer 2 and hearing instrument have not been paired</p>
<i>The pairing button on the TV Streamer 2 is pressed but no pairing melody is played in the hearing instrument</i>	<p>The TV Streamer 2 and hearing instrument are not within wireless range</p> <p>The TV Streamer 2 and hearing instrument have not been simultaneously in pairing mode</p>



POSSIBLE REMEDY

Carry out pairing process

Ensure that Remote Control and hearing instruments are within wireless range and activate streaming again

Carry out pairing process



Ensure that the TV Streamer 2 and hearing instruments are within wireless range, and repeat pairing process

Repeat pairing process and ensure that the battery doors on both hearing instruments are closed within 20 seconds after the pairing button has been pressed on the TV Streamer 2





SYMPTOM	CAUSE
<i>The streaming button on the Remote Control is pressed but no streamed audio signal is found when searched for (indicated by an 'X' icon on the display)</i>	<p>The TV Streamer 2 and hearing instruments are not within wireless range</p> <p>The TV Streamer 2 is not cabled correctly to the TV</p> <p>The TV Streamer 2 is powered off or the sound from the TV output has been muted</p>
<i>There is no sound in the hearing instruments although it is in the streaming program</i>	<p>The TV Streamer 2 and hearing instruments are not within wireless range</p> <p>The TV might have been powered off or the sound from the TV has been muted</p>
<i>The sound from the TV Streamer 2 is distorted</i>	<p>The audio input level from the TV is too high</p>





POSSIBLE REMEDY

Ensure that TV Streamer 2 and hearing instruments are within wireless range and activate streaming again

Connect the cable between the TV Streamer 2 and the TV correctly and activate streaming again

Power on the TV Streamer 2 or unmute the TV and activate streaming again



Ensure that the TV Streamer 2 and hearing instruments are within wireless range



Power on or unmute the TV

Adjust the volume using the volume button on the TV Streamer 2 until the sound is no longer distorted



SYMPTOM	CAUSE
<i>The volume level from the TV Streamer 2 is very low</i>	The audio input level from the TV is too low
<i>The sound from the TV Streamer 2 is distorted or drop-outs occur from time to time</i>	<p>The TV Streamer 2 and hearing instruments are on the edge of the wireless range</p> <p>The TV Streamer 2 and hearing instruments are not within sufficient "line-of-sight"</p>
<i>The sound from the TV Streamer 2 is not synchronized with the TV picture</i>	Your TV is not able to synchronize the sound from the selected audio outputs and the picture





POSSIBLE REMEDY

Adjust the volume using the "+" and "-" keys on the TV Streamer 2 until the sound is sufficiently loud

Move a little closer to the TV Streamer 2

Ensure that the TV Streamer 2 is placed in an adequate position, and that you are within normal reach without any significant obstacles obstructing the streaming



If possible, try using another audio output from your TV. Alternatively, follow the instructions in the "Adjustable delay mode" section of this user guide. If this does not help, contact your TV dealer

The TV Streamer 2 audio streaming has almost no latency and does not contribute itself to any lip sync error





SYMPTOM	CAUSE
<i>The sound from the TV Streamer 2 is not synchronized with the sound from the TV loudspeakers</i>	Your TV is not able to synchronize the sound from the selected audio outputs with the sound from the TV loudspeakers
<i>The sound from the hearing instruments is either too low or too high</i>	The audio input level is not suitable for listening
<i>A hearing instrument unintentionally drops out of the streaming programme</i>	The TV Streamer 2 and hearing instruments have been out of wireless range for more than 5 minutes The battery in the hearing instrument is so depleted that it no longer supports audio streaming





POSSIBLE REMEDY

If possible, try using another audio output from your TV. Alternatively, follow the instructions in the “Adjustable delay mode” section of this user guide. If this does not help, contact your TV dealer

The TV Streamer 2 audio streaming has almost no latency and does not contribute itself to any echo effects

Adjust the volume using the “+” and “-” keys on the TV Streamer 2 until the sound is suitable.

Alternatively, use the “+” and “-” keys on the Remote Control (optional) for this operation

Ensure that TV Streamer 2 and hearing instruments are within wireless range and activate streaming again

Replace the battery in the hearing instrument with a new one



Notes:

Multiple horizontal lines for writing notes.





Notes:

Be aware of information marked with the warning symbol



WARNING points out a situation that could lead to serious injuries,

CAUTION indicates a situation that could lead to minor and moderate injuries



Advice and tips on how to handle your accessory better.



Equipment includes RF transmitter



Product is a Type B applied part



Manufactured under license from Dolby Laboratories. Dolby and the double-D symbol are trademarks of Dolby Laboratories.



Please ask your local hearing care professional concerning disposal of your accessory



Any issues relating to the EU Medical Device Directive 93/42/EEC and R&TTE Directive 1999/5/EE C should be directed to GN Hearing A/S, Lautrupbjerg 7, DK 2750 Ballerup, Denmark

Worldwide Headquarters

ReSound A/S
Lautrupbjerg 7
DK-2750 Ballerup, Denmark
Tel.: +45 45 75 11 11
Fax: +45 45 75 11 19
www.resound.com

United Kingdom

GN ReSound Ltd.
Kirtlington Business Centre
Portway
Kirtlington
Oxon OX5 3JA
Tel.: +44 1869 352 800
Fax: +44 1869 343 466
www.gnresound.co.uk

Australia

GN ReSound Pty. Ltd.
Unit R1 Regents Park Estate
391 Park Road
Regents Park NSW 2143
Tel.: (free) 1800 658 955
Fax: +61 2 9743 7472
www.gnresound.com.au

New Zealand

GN ReSound (NZ) Ltd.
Ground Floor, North Entrance
4 Fred Thomas Drive
Takapuna
Auckland, 0622
Tel.: (free) 0800 900 126
Fax: (free) 0800 007 695
www.gnresound.co.nz

400248245-GB-13.11-Rev.A